

## Surface mount zener diode

### FEATURES

- Planar die construction
- 200mW power dissipation on ceramic PBC
- General purpose, medium current
- Ideally suited for automated assembly processes
- Available in lead free version

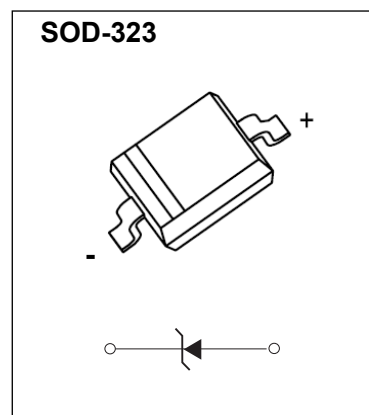

### Maximum Ratings ( $T_a=25^{\circ}\text{C}$ unless otherwise specified )

Characteristic	Symbol	Value	Unit
Forward Voltage (Note 2) @ $I_F = 10\text{mA}$	$V_F$	0.9	V
Power Dissipation(Note 1)	$P_D$	200	mW
Thermal Resistance from Junction to Ambient	$R_{\theta JA}$	625	$^{\circ}\text{C}/\text{W}$
Junction Temperature	$T_j$	150	$^{\circ}\text{C}$
Storage Temperature Range	$T_{stg}$	-55~+150	$^{\circ}\text{C}$



# BZT52C2V4S-BZT52C43S

## ELECTRICAL CHARACTERISTICS

T<sub>a</sub>=25°C unless otherwise specified

TYPE	Marking	Zener Voltage Range (Note 2)				Maximum Zener Impedance (Note 3)			Maximum Reverse Current (Note 2)		Typical Temperature Coefficient @I <sub>ZTC</sub> mV/°C		Test Current I <sub>ZTC</sub>
		V <sub>Z</sub> @I <sub>ZT</sub>			I <sub>ZT</sub>	Z <sub>ZT</sub> @I <sub>ZT</sub>	Z <sub>ZK</sub> @I <sub>ZK</sub>	I <sub>ZK</sub>	I <sub>R</sub>	V <sub>R</sub>	Min	Max	mA
		Nom(V)	Min(V)	Max(V)	(mA)	Ω		(mA)	μA	V			
BZT52C2V4S	WX	2.4	2.20	2.60	5	100	600	1.0	50	1.0	-3.5	0	5
BZT52C2V7S	W1	2.7	2.5	2.9	5	100	600	1.0	20	1.0	-3.5	0	5
BZT52C3V0S	W2	3.0	2.8	3.2	5	95	600	1.0	10	1.0	-3.5	0	5
BZT52C3V3S	W3	3.3	3.1	3.5	5	95	600	1.0	5	1.0	-3.5	0	5
BZT52C3V6S	W4	3.6	3.4	3.8	5	90	600	1.0	5	1.0	-3.5	0	5
BZT52C3V9S	W5	3.9	3.7	4.1	5	90	600	1.0	3	1.0	-3.5	0	5
BZT52C4V3S	W6	4.3	4.0	4.6	5	90	600	1.0	3	1.0	-3.5	0	5
BZT52C4V7S	W7	4.7	4.4	5.0	5	80	500	1.0	3	2.0	-3.5	0.2	5
BZT52C5V1S	W8	5.1	4.8	5.4	5	60	480	1.0	2	2.0	-2.7	1.2	5
BZT52C5V6S	W9	5.6	5.2	6.0	5	40	400	1.0	1	2.0	-2	2.5	5
BZT52C6V2S	WA	6.2	5.8	6.6	5	10	150	1.0	3	4.0	0.4	3.7	5
BZT52C6V8S	WB	6.8	6.4	7.2	5	15	80	1.0	2	4.0	1.2	4.5	5
BZT52C7V5S	WC	7.5	7.0	7.9	5	15	80	1.0	1	5.0	2.5	5.3	5
BZT52C8V2S	WD	8.2	7.7	8.7	5	15	80	1.0	0.7	5.0	3.2	6.2	5
BZT52C9V1S	WE	9.1	8.5	9.6	5	15	100	1.0	0.5	6.0	3.8	7.0	5
BZT52C10S	WF	10	9.4	10.6	5	20	150	1.0	0.2	7.0	4.5	8.0	5
BZT52C11S	WG	11	10.4	11.6	5	20	150	1.0	0.1	8.0	5.4	9.0	5
BZT52C12S	WH	12	11.4	12.7	5	25	150	1.0	0.1	8.0	6.0	10.0	5
BZT52C13S	WI	13	12.4	14.1	5	30	170	1.0	0.1	8.0	7.0	11.0	5
BZT52C15S	WJ	15	13.8	15.6	5	30	200	1.0	0.1	10.5	9.2	13	5
BZT52C16S	WK	16	15.3	17.1	5	40	200	1.0	0.1	11.2	10.4	14	5
BZT52C18S	WL	18	16.8	19.1	5	45	225	1.0	0.1	12.6	12.4	16	5
BZT52C20S	WM	20	18.8	21.2	5	55	225	1.0	0.1	14.0	14.4	18.0	5
BZT52C22S	WN	22	20.8	23.3	5	55	250	1.0	0.1	15.4	16.4	20.0	5
BZT52C24S	WO	24	22.8	25.6	5	70	250	1.0	0.1	16.8	18.4	22.0	5
BZT52C27S	WP	27	25.1	28.9	2	80	300	0.5	0.1	18.9	21.4	25.3	2
BZT52C30S	WQ	30	28.0	32.0	2	80	300	0.5	0.1	21.0	24.4	29.4	2
BZT52C33S	WR	33	31.0	35.0	2	80	325	0.5	0.1	23.1	27.4	33.4	2
BZT52C36S	WS	36	34.0	38.0	2	90	350	0.5	0.1	25.2	30.4	37.4	2
BZT52C39S	WT	39	37.0	41.0	2	130	350	0.5	0.1	27.3	33.4	41.2	2
BZT52C43S	WU	43	40.0	46.0	2	100	700	1	0.1	32	10	12	5

Notes: 1. Device mounted on ceramic PCB: 7.6mm x 9.4mm x 0.87mm with pad areas 25mm<sup>2</sup>.

2. Short duration test pulse used to minimize self-heating effect.

3. f = 1kHz.

## Typical Characteristics

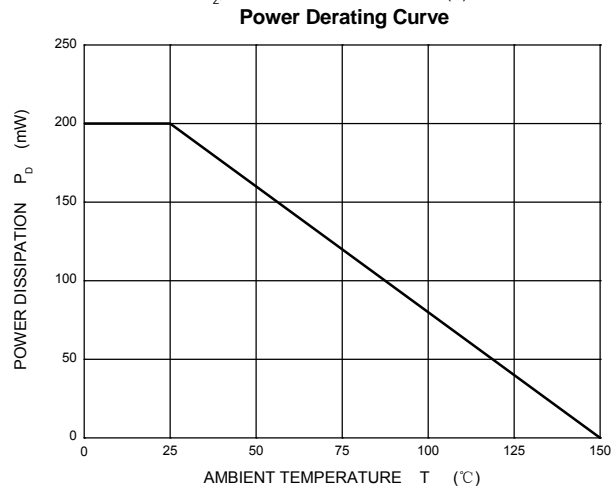
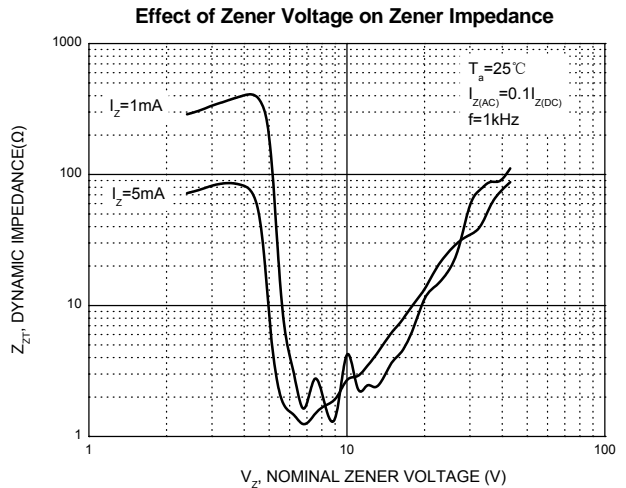
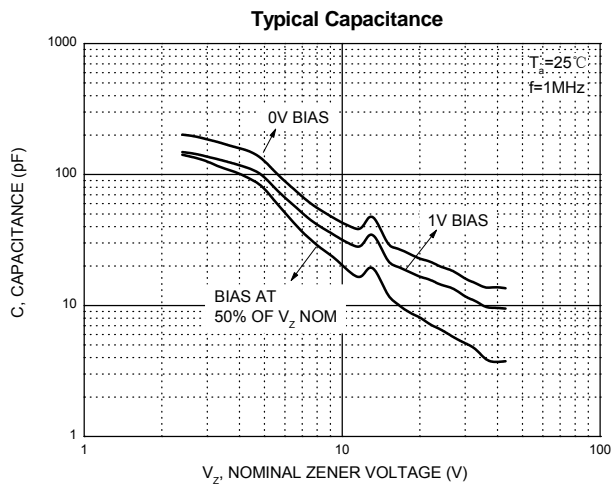
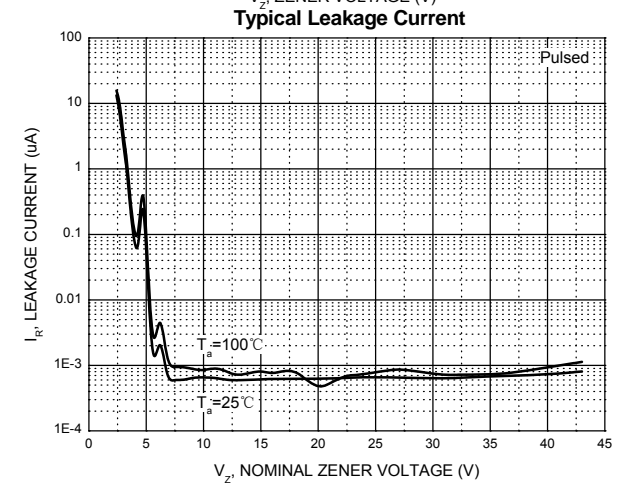
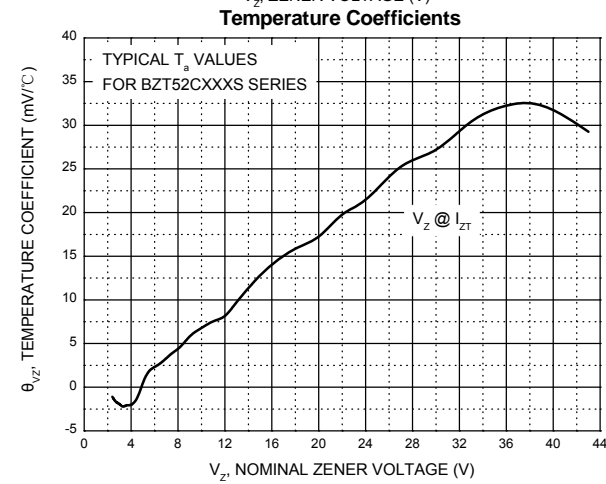
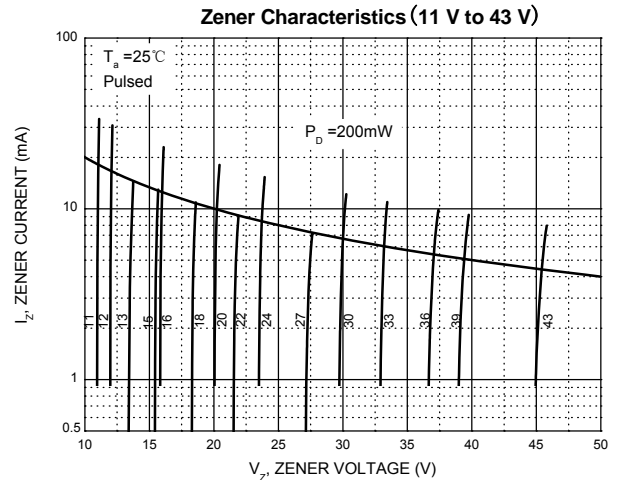
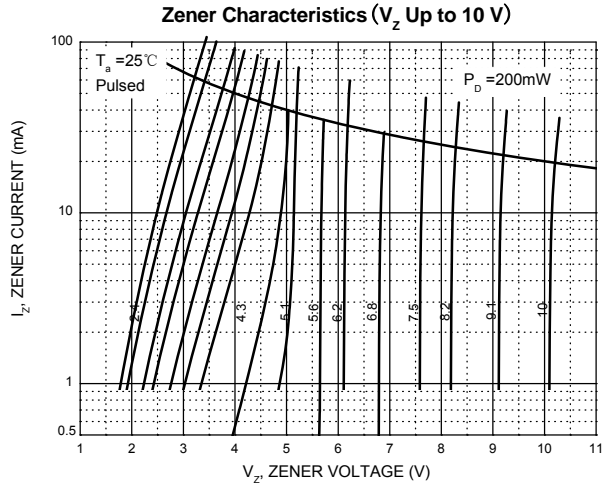

## SOD-323 Package Outline Dimensions

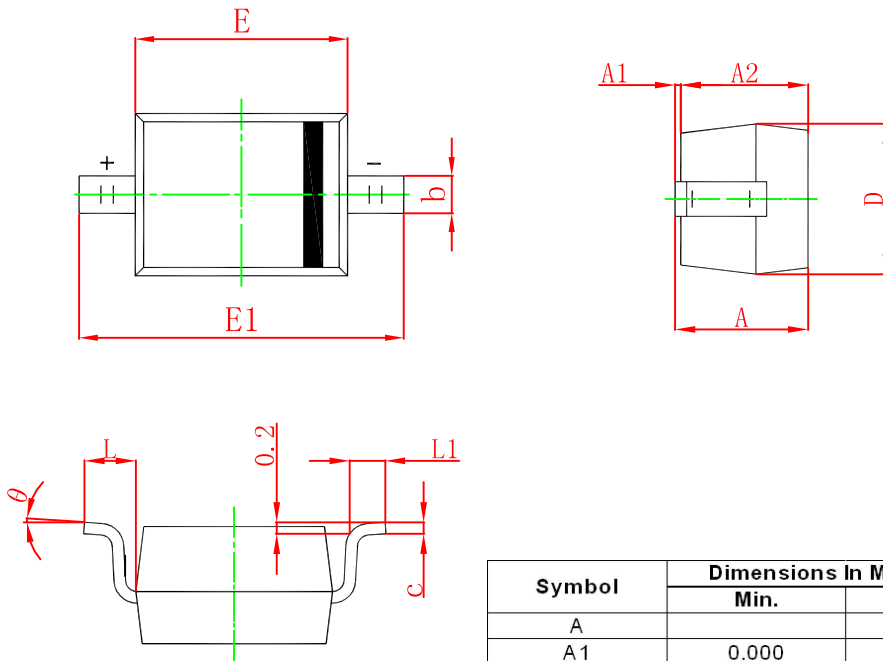

Symbol	Dimensions In Millimeters		Dimensions In Inches	
	Min.	Max.	Min.	Max.
A		1.000		0.039
A1	0.000	0.100	0.000	0.004
A2	0.800	0.900	0.031	0.035
b	0.250	0.350	0.010	0.014
c	0.080	0.150	0.003	0.006
D	1.200	1.400	0.047	0.055
E	1.600	1.800	0.063	0.071
E1	2.550	2.750	0.100	0.108
L	0.475 REF.		0.019 REF.	
L1	0.250	0.400	0.010	0.016
θ	0°	8°	0°	8°

## SOD-323 Suggested Pad Layout

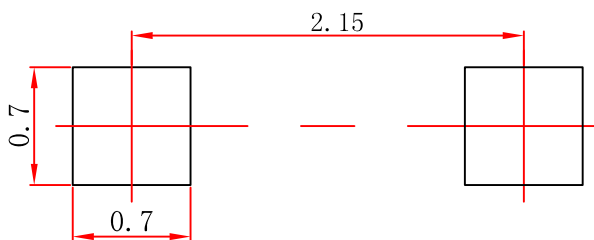

### Note:

1. Controlling dimension: in millimeters.
2. General tolerance:  $\pm 0.05\text{mm}$ .
3. The pad layout is for reference purposes only.