

600V High and Low Side Driver

PRODUCT SUMMARY

- V_{OFFSET} 600 V max.
- $I_{\text{O}+/-}$ 2.5A / 3.5A
- V_{OUT} 10 V - 20 V
- $t_{\text{on/off}}$ (typ.) 180ns / 200ns

GENERAL DESCRIPTION

The SL27714 is a high voltage, high speed power MOSFET and IGBT drivers with independent high- and low-side referenced output channels. Proprietary HVIC and latch immune CMOS technologies enable ruggedized monolithic construction. The logic input is compatible with standard CMOS or LSTTL output, down to 3.3 V logic. The output drivers feature a high pulse current buffer stage designed for minimum driver cross conduction. Propagation delays are matched to simplify use in high frequency applications. The floating channel can be used to drive an N-channel power MOSFET or IGBT in the high-side configuration which operates up to 600 V.

FEATURES

- Floating channel designed for bootstrap operation
- Fully operational to +600 V
- Low V_{CC} operation
- Tolerant to negative transient voltage, dV/dt immune
- Gate drive supply range from 10 V to 20 V
- Undervoltage lockout for both channels
- 3.3 V, and 5 V logic compatible
- CMOS Schmitt-triggered inputs with pull-down
- Matched propagation delay for both channels
- Outputs in phase with inputs
- RoHS compliant
- SOP14 package

TYPICAL APPLICATION CIRCUIT

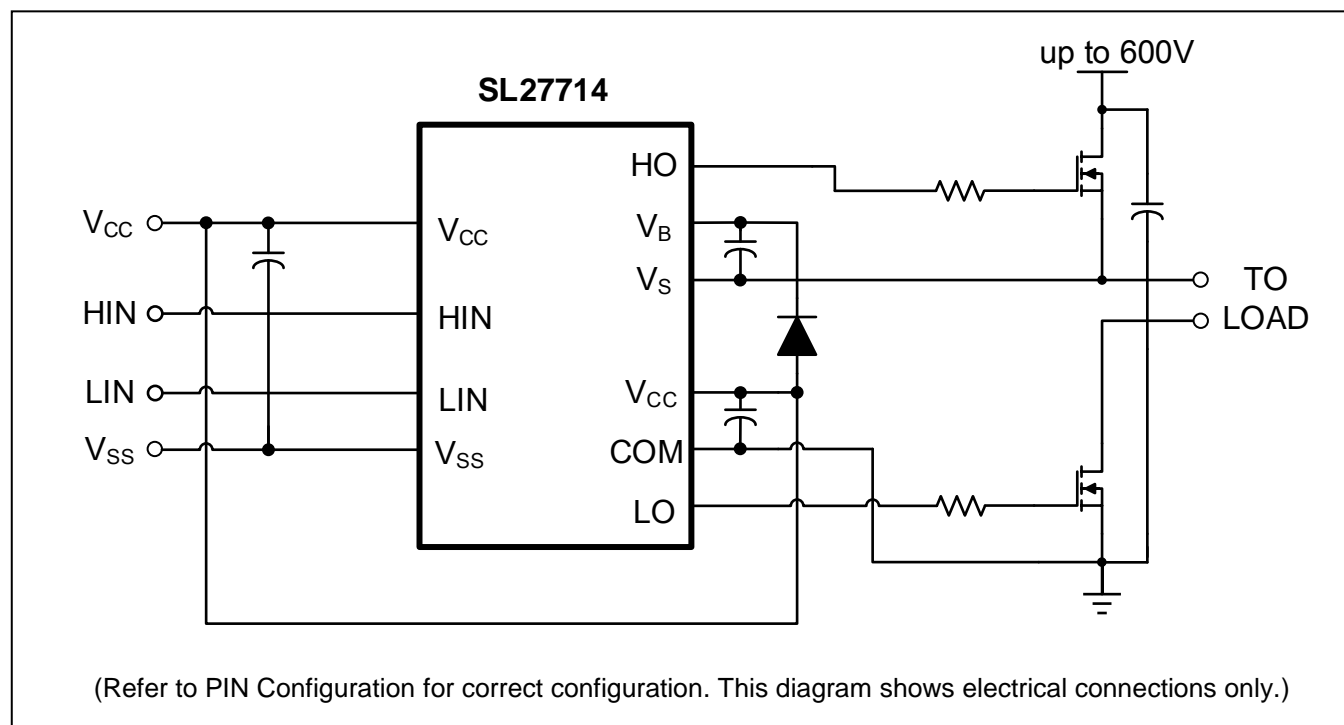

PIN CONFIGURATION

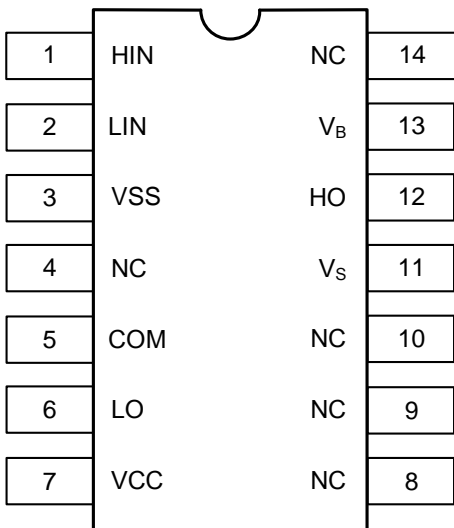
Package	Pin Configuration (Top View)
SOP14	

PIN DESCRIPTION

No.	Pin	Description
1	HIN	Logic input for high-side gate driver output (HO), in phase
2	LIN	Logic input for low-side gate driver output (LO), in phase
3	VSS	Logic ground
5	COM	Low-side return
6	LO	Low-side gate drive output
7	V _{CC}	Low-side and logic fixed supply
11	V _S	High-side floating supply return
12	HO	High-side gate drive output
13	V _B	High-side floating supply
4,8,9,10, 14	NC	No Connection

ORDERING INFORMATION

Industrial Range: -40°C to +125°C

Order Part No.	Package	QTY
SL27714	SOP14, Pb-Free	2500/Reel

FUNCTIONAL BLOCK DIAGRAM

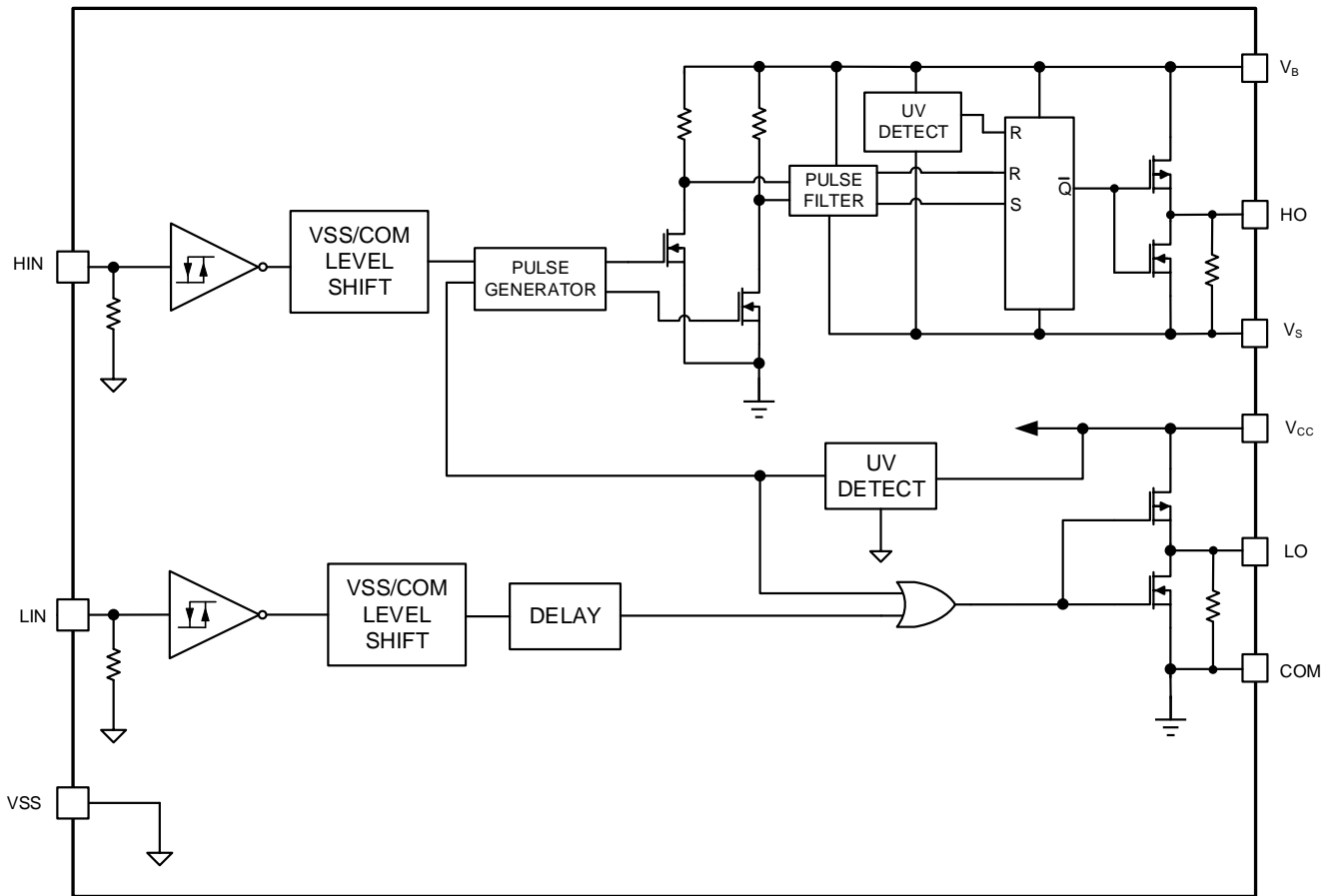

ABSOLUTE MAXIMUM RATINGS

Symbol	Definition	Min.	Max.	Units	
V _B	High-side floating absolute voltage	-0.3	625	V	
V _S	High-side floating supply offset voltage	V _B - 25	V _B + 0.3		
V _{HO}	High-side floating output voltage	V _S - 0.3	V _B + 0.3		
V _{CC}	Low-side and logic fixed supply voltage	-0.3	25		
V _{LO}	Low-side output voltage	-0.3	V _{CC} + 0.3		
V _{IN}	Logic input voltage (HIN & LIN)	V _{SS} -0.3	V _{SS} + V _{CC}		
V _{SS}	Logic ground	-5	+5		
dV _S /dt	Allowable offset supply voltage transient	---	50	V/ns	
P _D	Package power dissipation @ T _A ≤ +25°C	SOP14	---	1.0	W
θ _{JA}	Thermal resistance, junction to ambient	SOP14	---	120	°C/W
T _J	Junction temperature	---	150	°C	
T _S	Storage temperature	-55	150		
T _L	Lead temperature (soldering, 10 seconds)	---	300		

Note: Absolute maximum ratings indicate sustained limits beyond which damage to the device may occur. All voltage parameters are absolute voltages referenced to COM. The thermal resistance and power dissipation ratings are measured under board mounted and still air conditions.

RECOMMENDED OPERATION CONDITIONS

Symbol	Definition	Min	Max	Units
V _B	High-side floating absolute voltage	V _S + 10	V _S + 20	V
V _S	High-side floating supply offset voltage		600	
V _{HO}	High-side floating output voltage	V _S	V _B	
V _{CC}	Low-side and logic fixed supply voltage	10	20	
V _{LO}	Low-side output voltage	0	V _{CC}	
V _{IN}	Logic input voltage (HIN & LIN)	V _{SS}	V _{SS} +V _{CC}	
T _A	Ambient temperature	- 40	125	°C

Note: For proper operation the device should be used within the recommended conditions. The V_S offset rating is tested with all supplies biased at a 15 V differential.

DYNAMIC ELECTRICAL CHARACTERISTICS

$V_{BIAS} (V_{CC}, V_{BS}) = 15\text{ V}$, $C_L = 1000\text{ pF}$ and $T_A = 25^\circ\text{C}$ unless otherwise specified.

Symbol	Parameter	Condition	Min.	Typ.	Max.	Unit
t_{on}	Turn-on propagation delay	$V_S = 0\text{ V}$	---	180	270	ns
t_{off}	Turn-off propagation delay	$V_S = 0\text{ V}$	---	200	300	
t_r	Turn-on rise time		---	10	20	
t_f	Turn-off fall time		---	8	20	
MT	Delay matching, HS & LS turn-on/off		---	0	35	

STATIC ELECTRICAL CHARACTERISTICS

$V_{BIAS} (V_{CC}, V_{BS}) = 15\text{ V}$, $V_{SS} = \text{COM}$ and $T_A = 25^\circ\text{C}$ unless otherwise specified. The V_{IN} , V_{TH} , and I_{IN} parameters are referenced to V_{SS}/COM and are applicable to the logic input leads: HIN and LIN. The V_O and I_O parameters are referenced to COM and are applicable to the respective output leads: HO and LO.

Symbol	Parameter	Condition	Min.	Typ.	Max.	Unit
V_{IH}	Logic "1" input voltage	$V_{CC} = 10\text{ V to }20\text{ V}$	2.5	---	---	V
V_{IL}	Logic "0" input voltage		---	---	0.8	
V_{OH}	High level output voltage, $V_{BIAS} - V_O$	$I_O = 20\text{ mA}$	---	---	0.2	
V_{OL}	Low level output voltage, V_O		---	0.02	0.15	
I_{LK}	Offset supply leakage current	$V_B = V_S = 600\text{ V}$	---	---	50	
I_{QBS}	Quiescent V_{BS} supply current	$V_{IN} = 0\text{ V}$	30	65	100	
I_{QCC}	Quiescent V_{CC} supply current		200	270	350	
I_{IN+}	Logic "1" input bias current	$HIN=LIN = 5\text{ V}$	---	27	35	
I_{IN-}	Logic "0" input bias current	$HIN=LIN = 0\text{ V}$	---	---	5	
V_{BSUV+}	V_{BS} supply undervoltage positive going threshold		8.0	8.9	9.8	V
V_{BSUV-}	V_{BS} supply undervoltage negative going threshold		7.4	8.2	9.0	V
V_{CCUV+}	V_{CC} supply undervoltage positive going threshold		8.0	8.9	9.8	V
V_{CCUV-}	V_{CC} supply undervoltage negative going threshold		7.4	8.2	9.0	
I_{O+}	Output high short circuit pulsed current	$V_O = 0\text{ V}$ $V_{IN} = \text{Logic "1"}$ $PW \leq 10\ \mu\text{s}$		2.5		A
I_{O-}	Output low short circuit pulsed current	$V_O = 15\text{ V}$ $V_{IN} = \text{Logic "0"}$ $PW \leq 10\ \mu\text{s}$		3.5		

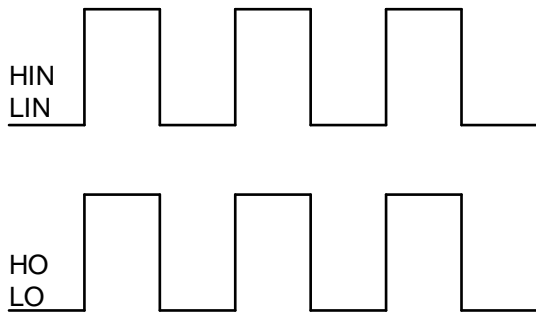

Figure 1. Input/Output Timing Diagram

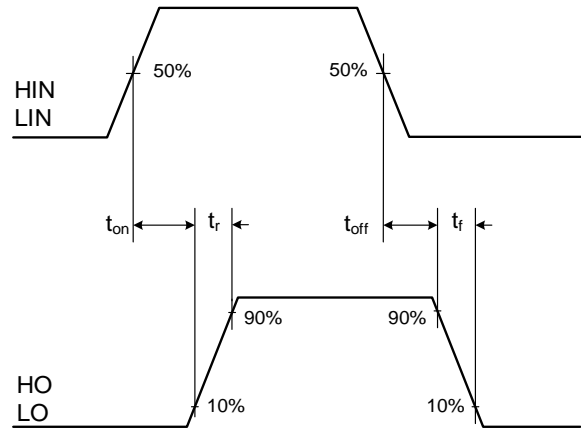

Figure 2. Switching Time Waveform

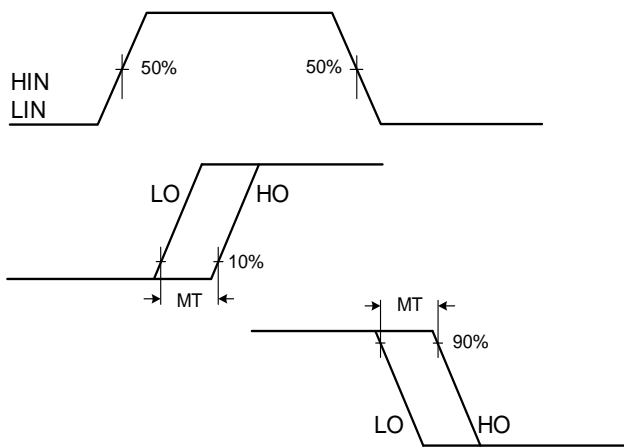

Figure 3. Delay Matching Waveform

TYPICAL PERFORMANCE CHARACTERISTICS

V_{BIAS} (V_{CC} , V_{BS}) = 15 V, V_{SS} =COM and T_A = 25°C unless otherwise specified.

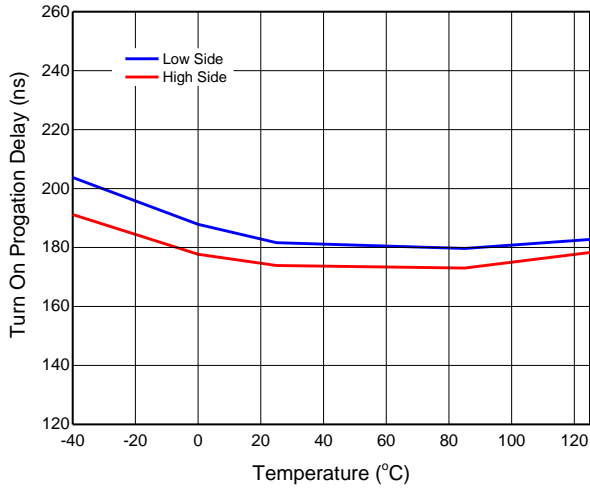

Figure 4. Turn On Delay vs. Temperature

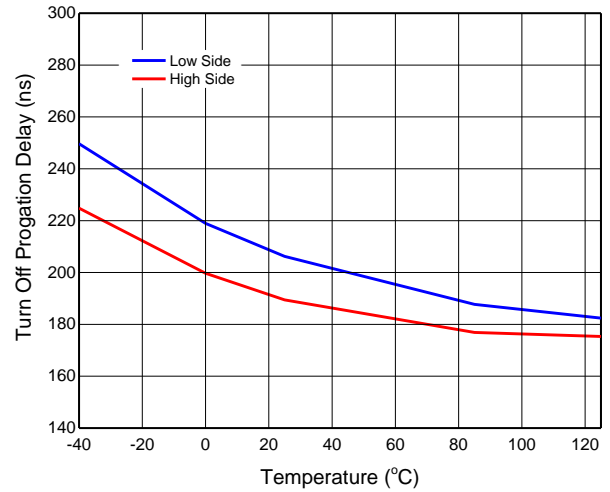

Figure 5. Turn Off Delay vs. Temperature

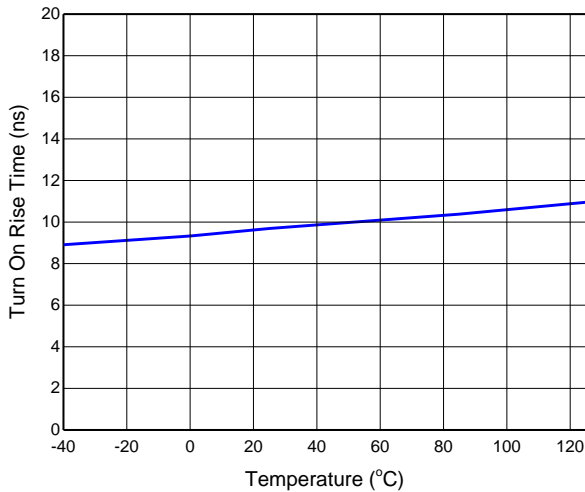

Figure 6. Turn On Rise Time vs. Temperature

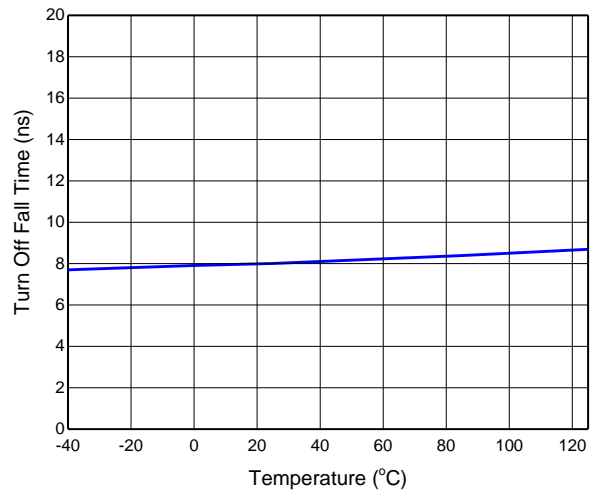

Figure 7. Turn Off Fall Time vs. Temperature

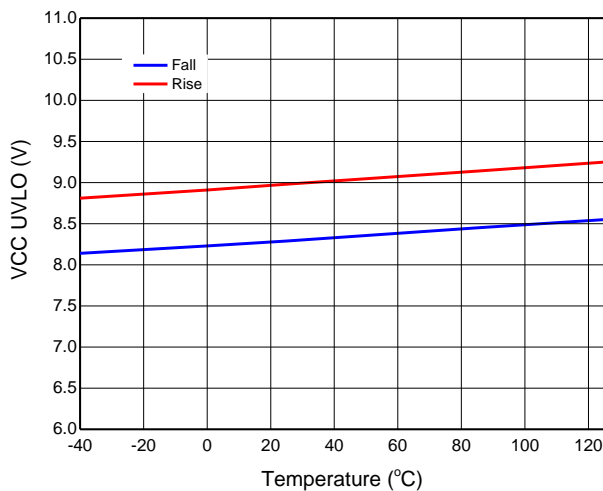

Figure 8. VCC UVLO Threshold vs. Temperature

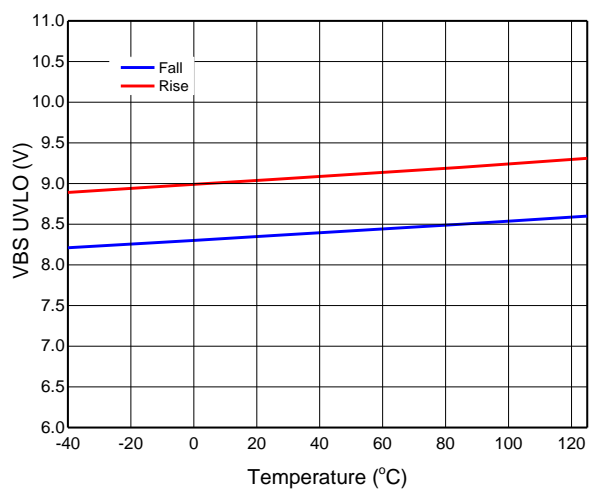

Figure 9. VBS UVLO Threshold vs. Temperature

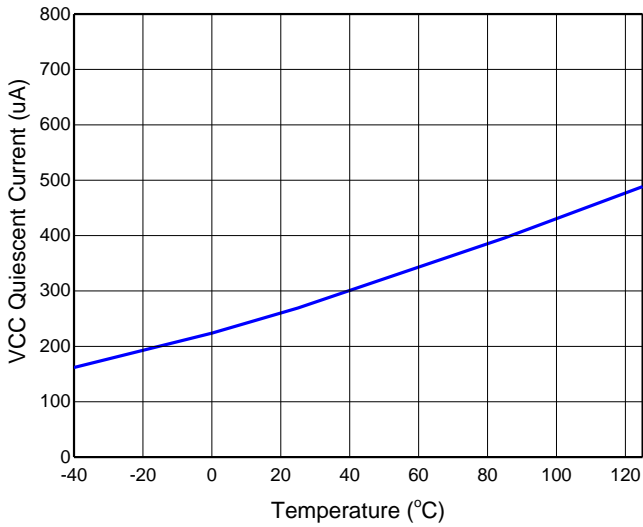

Figure 10. VCC Quiescent Current vs. Temperature

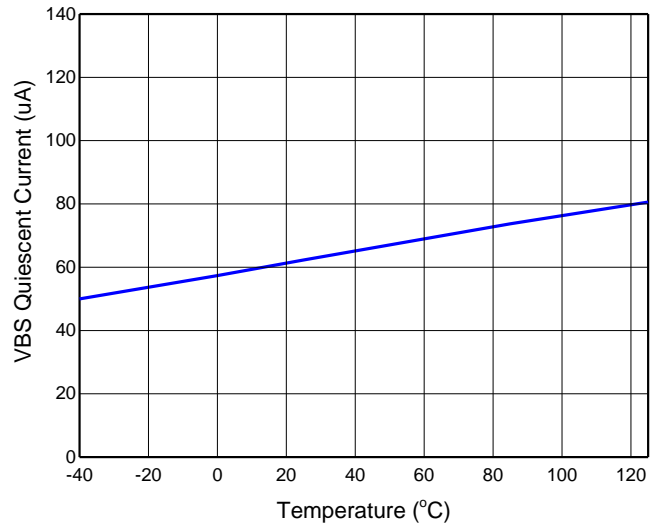

Figure 11. VBS Quiescent Current vs. Temperature

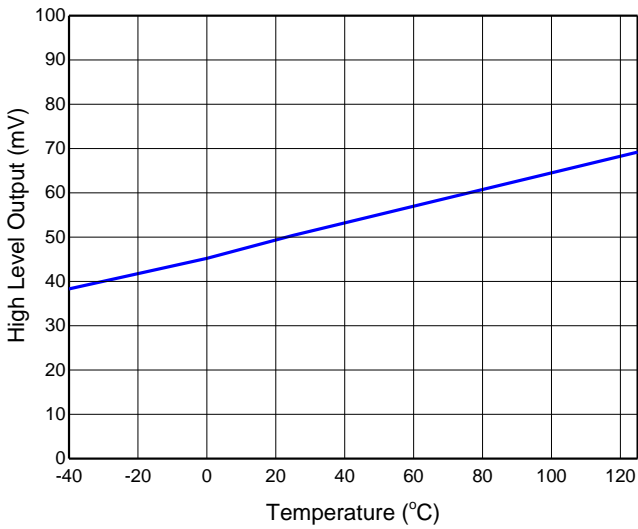

Figure 12. High Level Output vs. Temperature

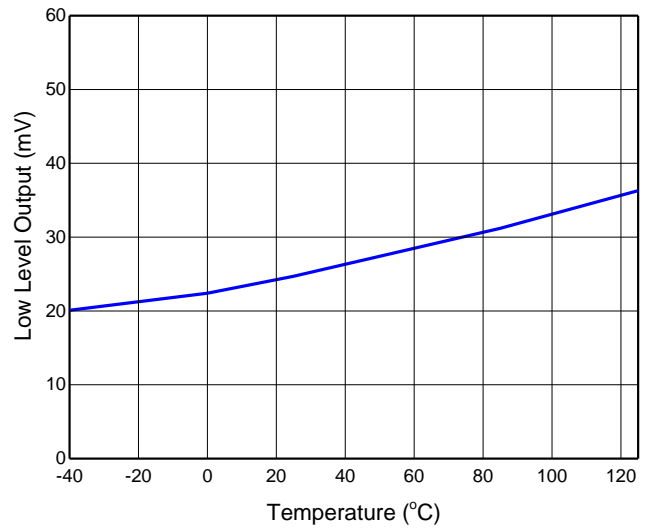

Figure 13. Low Level Output vs. Temperature

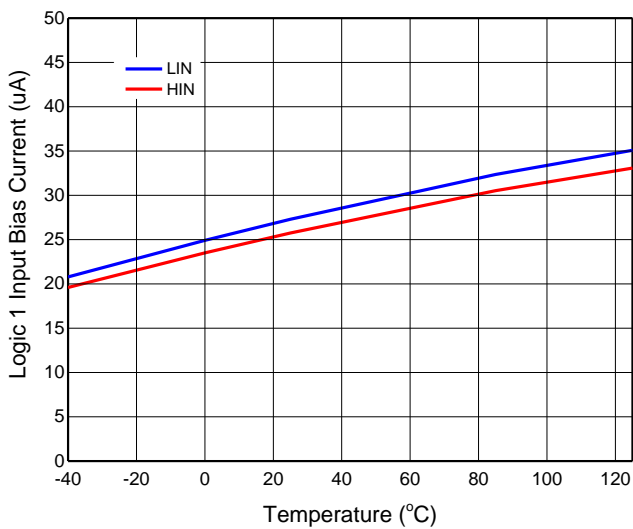
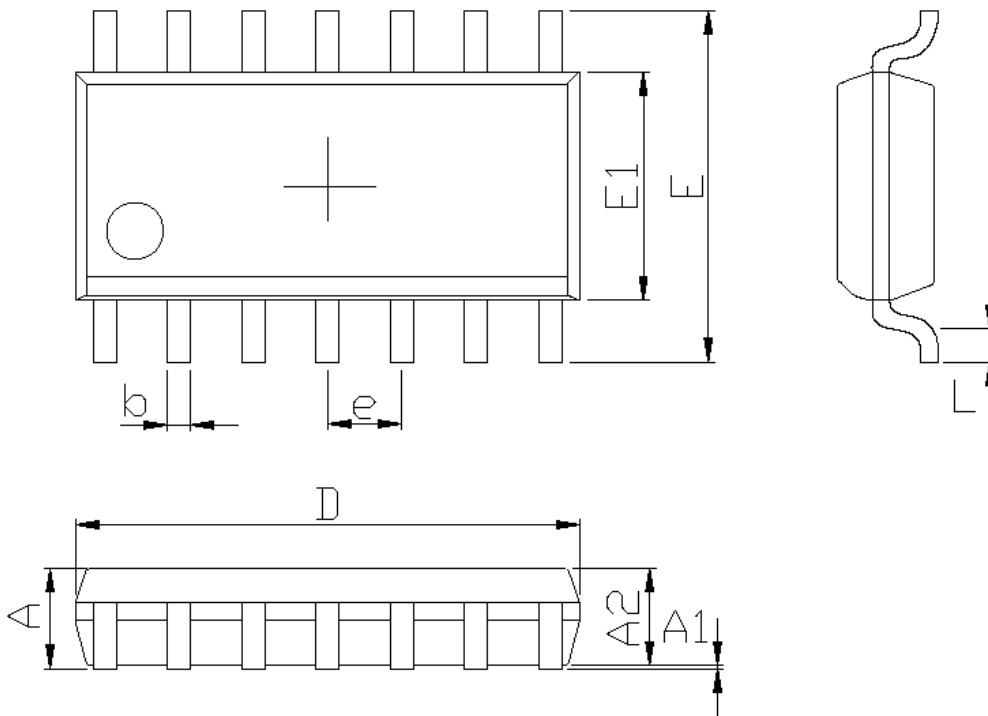

Figure 14. Logic "1" Input Bias Current vs. Temperature

PACKAGE CASE OUTLINES



Dimension	MIN	NOM	MAX
A	-	-	1.75
A1	0.05	-	0.20
A2	1.25	1.40	1.55
D	8.55	8.65	8.75
E	5.80	6.00	6.20
E1	3.80	3.90	4.00
e	1.27 BSC		
b	0.40 BSC		
L	0.40	-	0.70
Unit : mm			

Figure 15. SOP14 Outline Dimensions